

ВИДЫ ВНУТРЕННИХ ФРЕЗ КРОМОЧНЫЕ ФРЕЗЫ

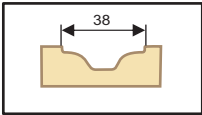

Фреза № 1
Для рисунков:
1, 2, 6, 7, 13, 15, 19, 36.
"Кантри", "Вестерн"

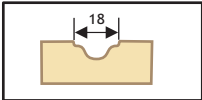

Фреза № 2
Для рисунков:
3, 8, 10, 17, 20, 21, 29, 37

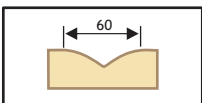

Фреза № 3
Для рисунков:
18, 23, 27

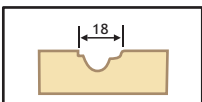

Фреза № 4
Для рисунков:
49

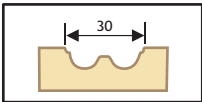

Фреза № 5
Для рисунков:
14, 29

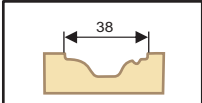

Фреза № 6
Для рисунков:
53

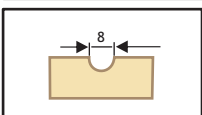

Фреза № 7
Для рисунков:
4, 5, 9, 33, 34, 35, 36, 37

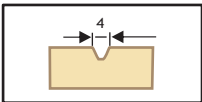

Фреза № 8
Для рисунков:
16, 31, 32, 38, 58, 59

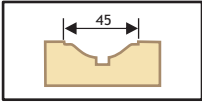

Фреза № 9
Для рисунков:
1, 2, 6, 7, 13, 26, 31, 36,
"Кантри", "Вестерн"

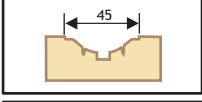

Фреза № 10 (9+8)
Для рисунков:
31

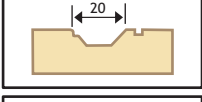

Фреза № 11
Для рисунков:
38

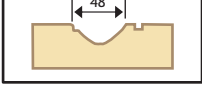

Фреза № 12
Для рисунков:
58, 59, 60

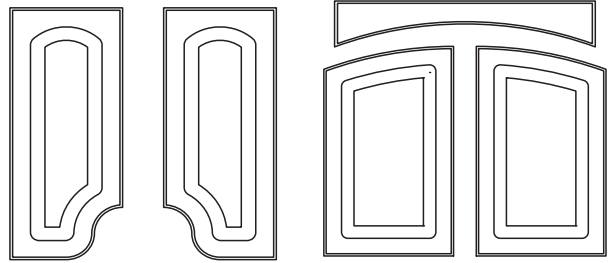
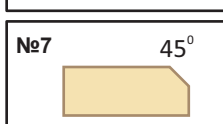
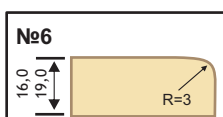
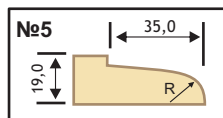
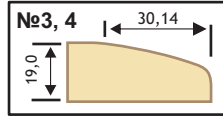
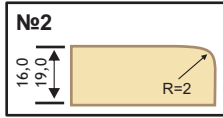
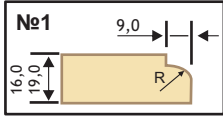
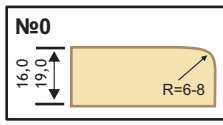

"Вестерн"

высота	ширина
570	596
570	796
713	596
713	796

"Кантри"

высота	ширина
713	596
713	696
713	796

Пилястры

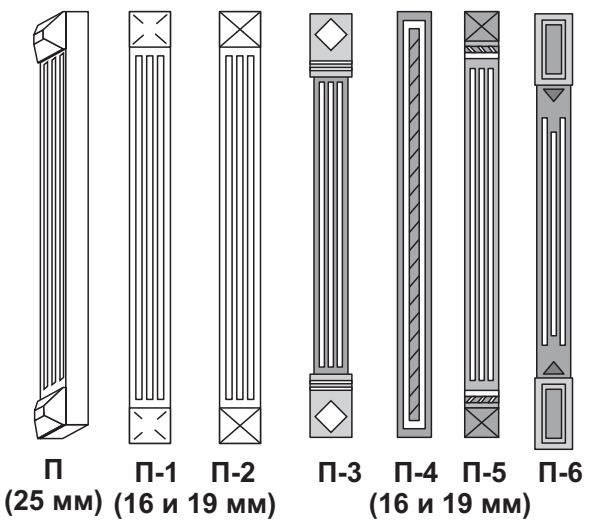

МДФ карнизы 38 мм.



Прямые МДФ карнизы

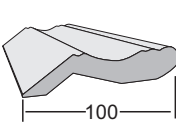

карниз "Супер"

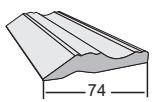

карниз "Поли"

Фрезеровка ручки в фасаде

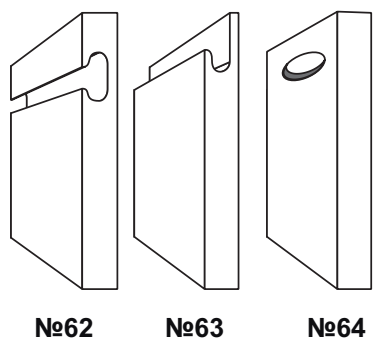

Сборные МДФ фасады

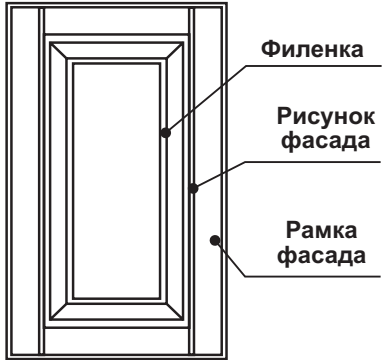

ФИЛЕНКА

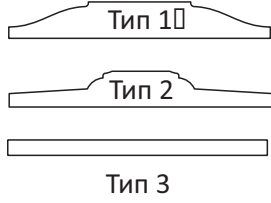

-Тип 1- только прямые фасады

ФАСАДЫ ИЗ ДСП

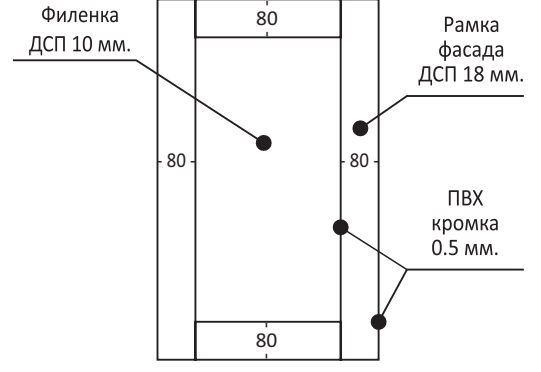

1

Категория сложности фрезеровки

Рисунки фрезерования (стандартная программа)

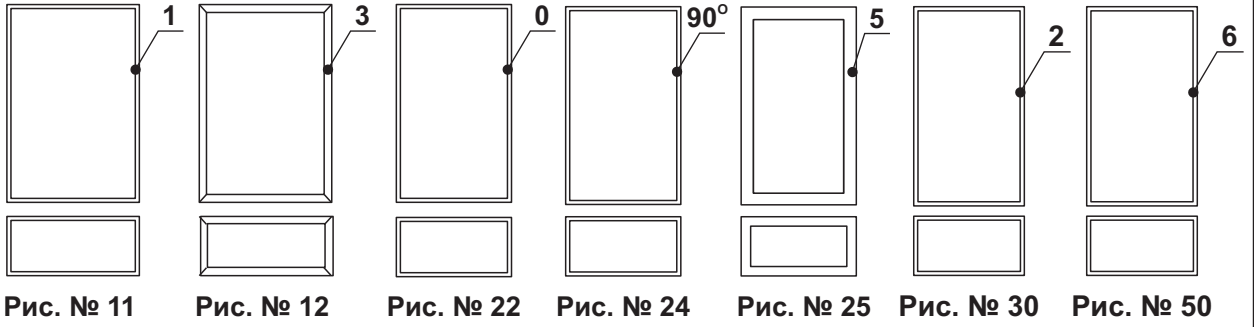
**2**

Категория сложности фрезеровки

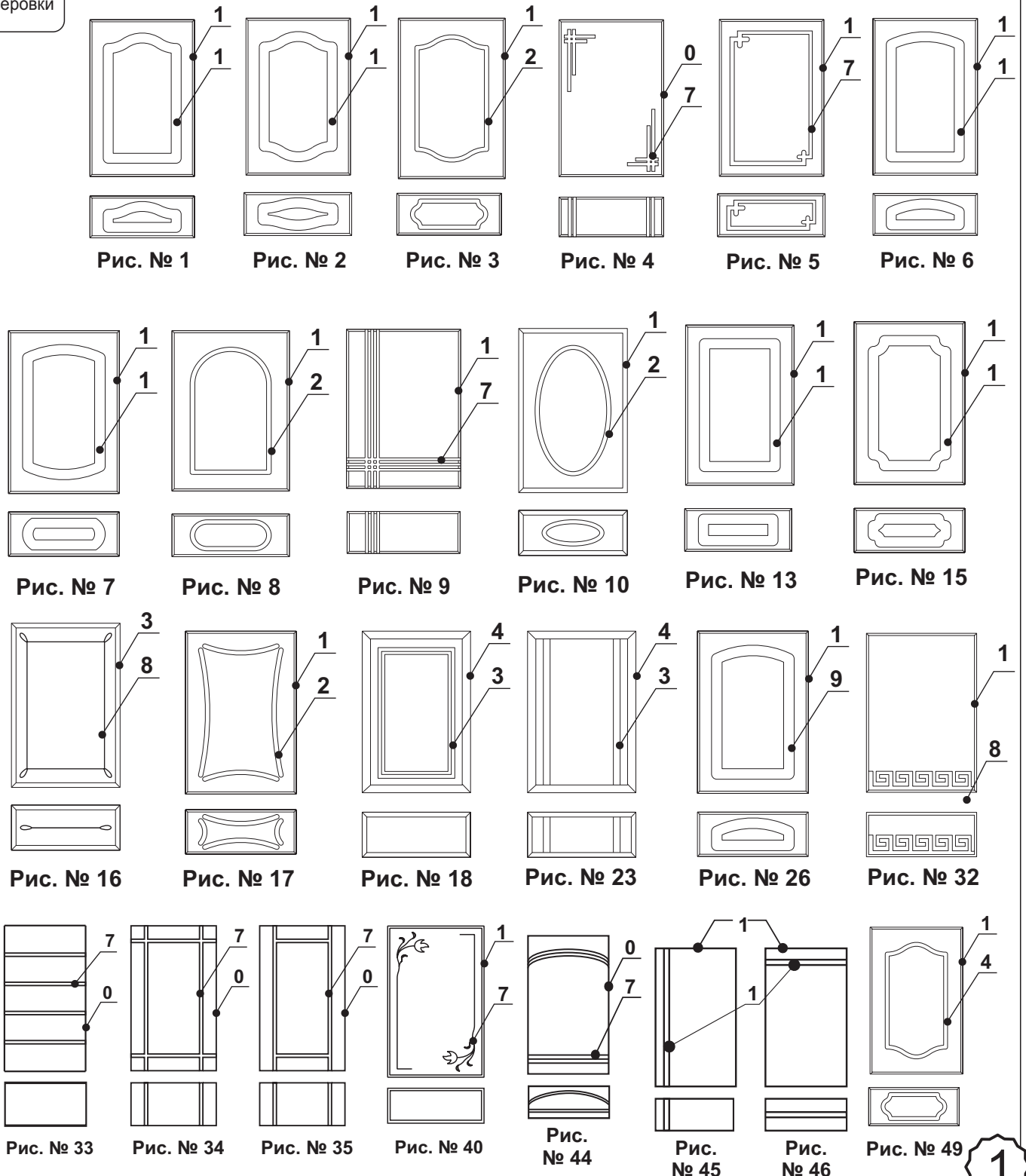

3 Категория сложности фрезеровки

Рисунки фрезерования (стандартная программа)



Рис. № 14



Рис. № 29

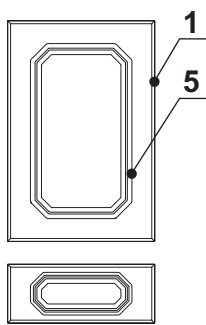

Рис. № 36

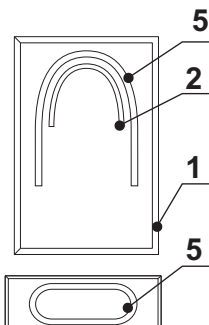

Рис. № 55

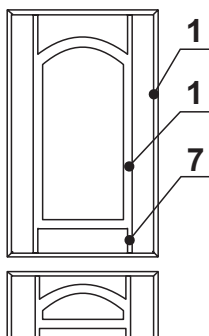

Рис. № 60

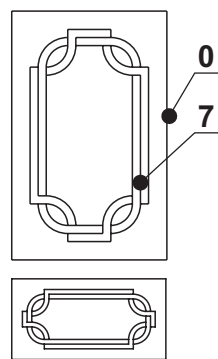

Рис. № 53

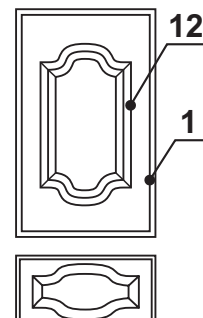

Рис. № 61

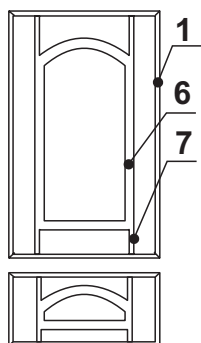

Рис. № 66

4 Категория сложности фрезеровки

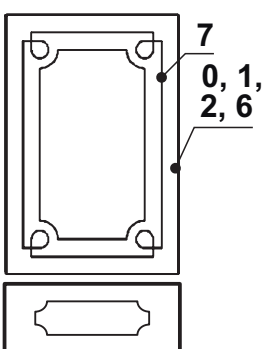

Рис. № 31

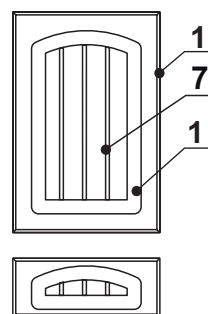

Рис. № 38

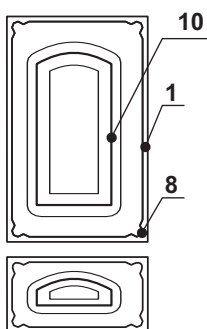

Рис. № 39

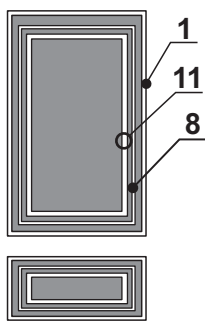

Рис. № 58

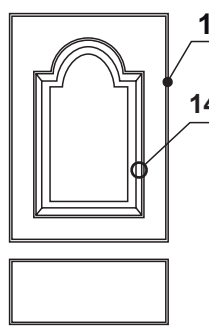

Рис. № 59

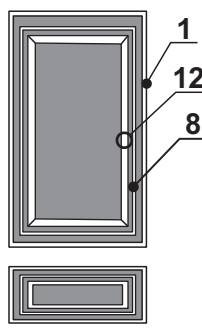

Рис. № 65

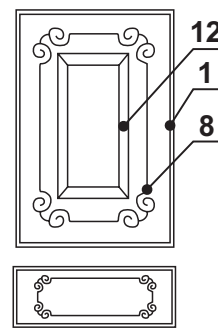

Рис. № 67

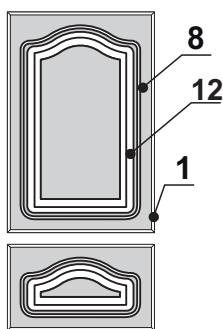

Рис. № 69

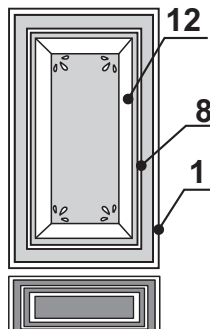

Рис. № 41

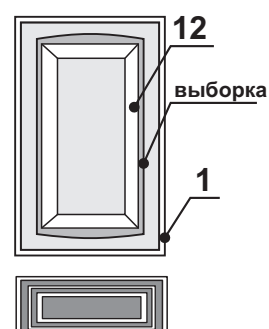

Рис. № 47
только на 19 мм.

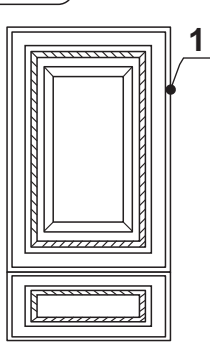

Рис. № 70

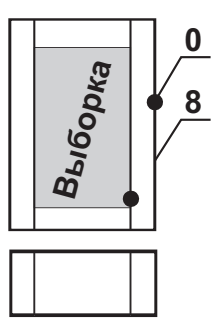

Рис. № 71

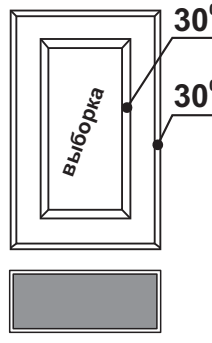

Рис. № 80

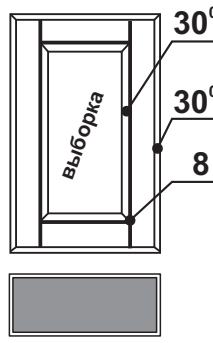

Рис. № 81

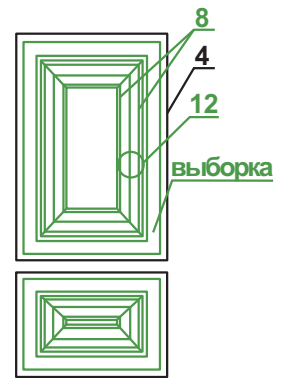

Рис. № 82

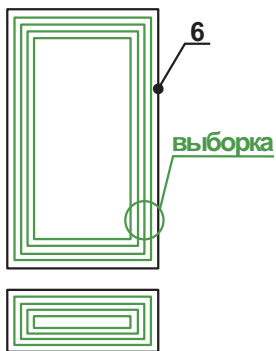

Рис. № 83

Витрины

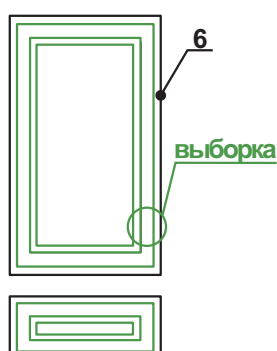

Витрина
Рис. № 19

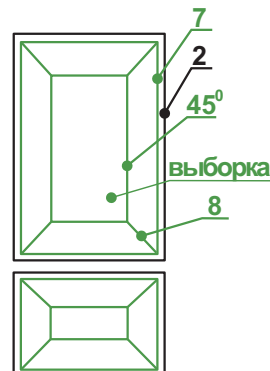
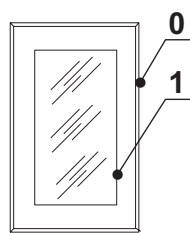
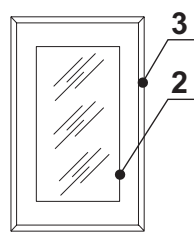

Витрина
Рис. № 20

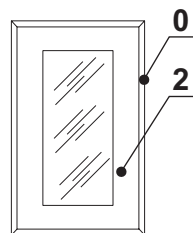

Витрина
Рис. № 21

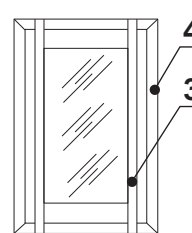

Витрина
Рис. № 27

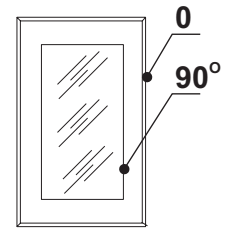

Витрина
Рис. № 28



Рис. № 37



Витрина
Рис. № 42
кроме пленочных фасадов

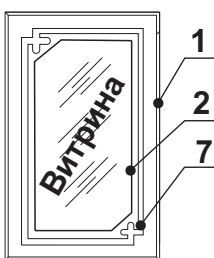
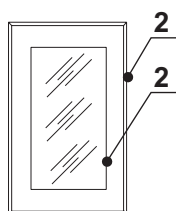
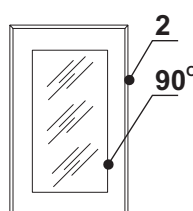

Витрина
Рис. № 43

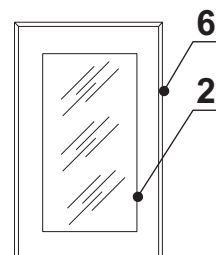

Витрина
Рис. № 51

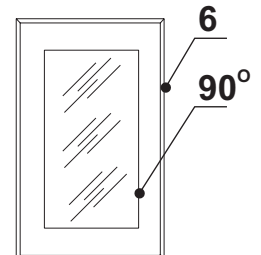

Витрина
Рис. № 52

Фрезеровка ручки в фасаде

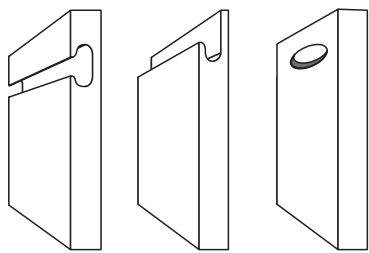

№62

№63

№64

Карнизы из МДФ

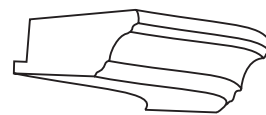
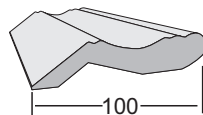
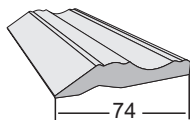

карниз
радиусный

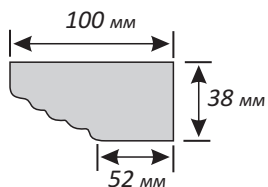

Корона

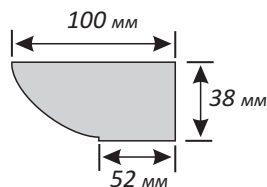

Клюв

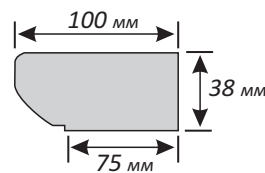

ST-2

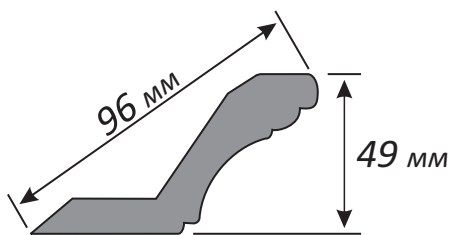

K-100

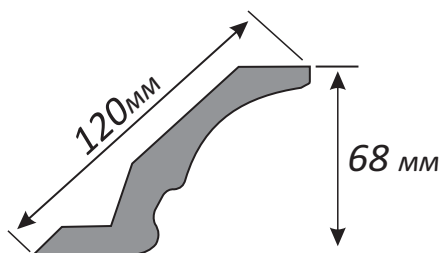

K-120

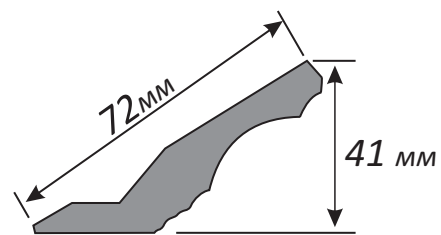

Поли